

Konstrukcja ambony myśliwskiej

Konstrukcja ściany zewnętrznej

www.lech-bud.org

Grzegorz Woźny

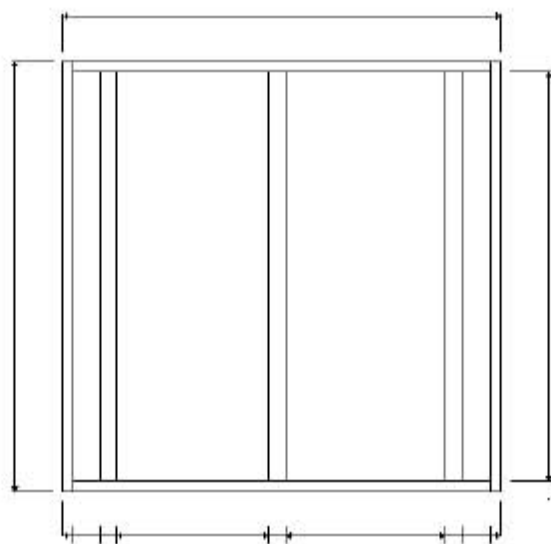
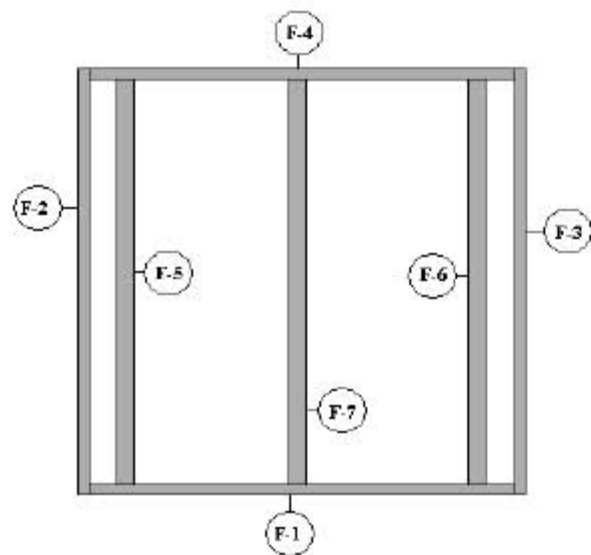

Nr. Elementu	Wymiar	Sztuki	m3

Konstrukcja ambony myśliwskiej

Konstrukcja dachu

www.lech-bud.org

Grzegorz Woźny

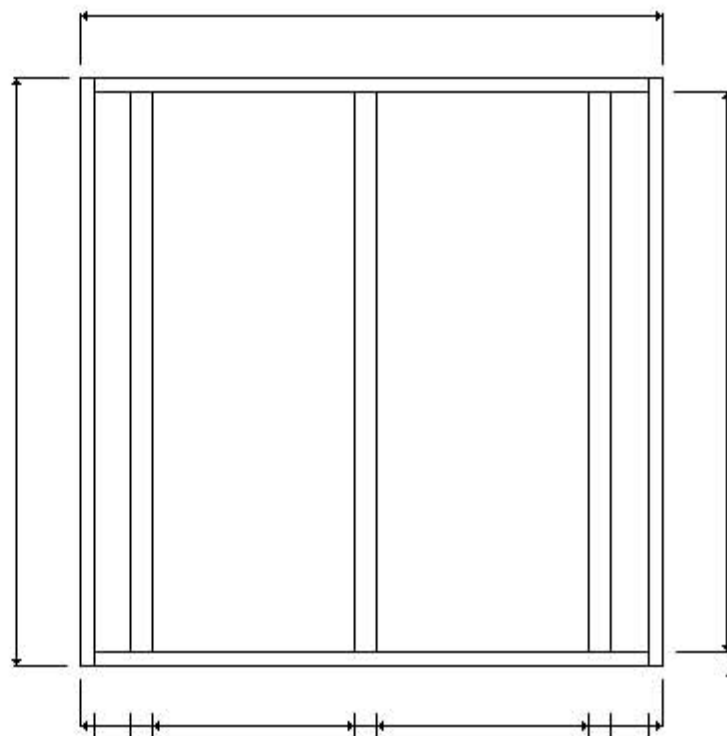

Konstrukcja ambony myśliwskiej

Konstrukcja dachu

www.lech-bud.org

Grzegorz Woźny

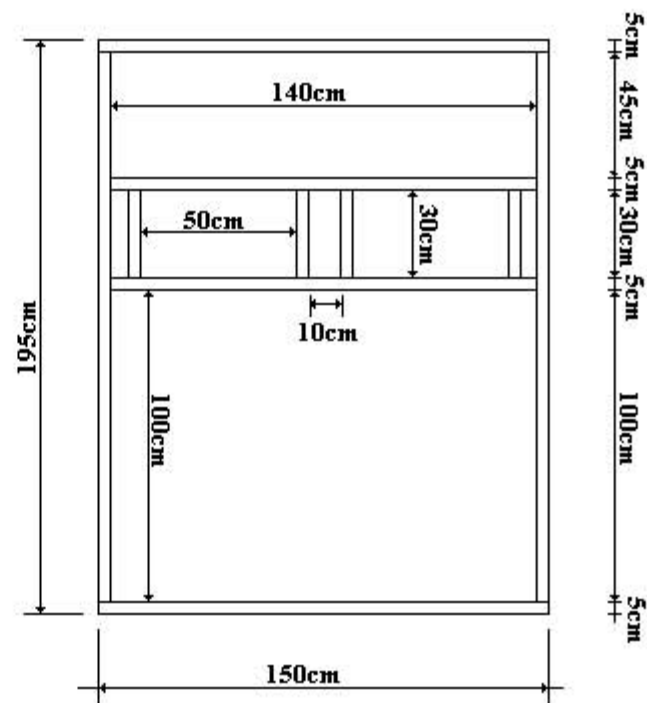
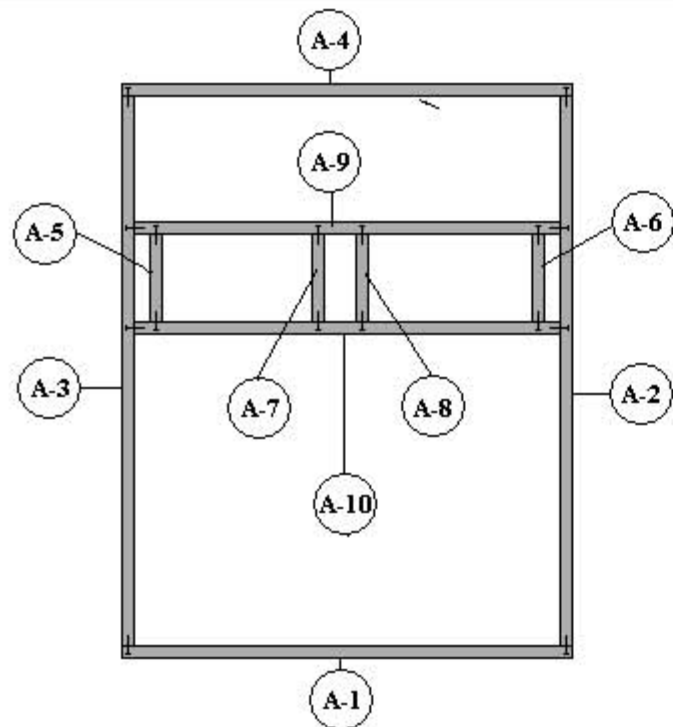

Nr. Elementu	Wymiar	Sztuki	mb	m3
A-1	5cm/5cm/150cm	1	150cm	0,0038
A-2	5cm/5cm/185cm	1	185cm	0,0046
A-3	5cm/5cm/185cm	1	185cm	0,0046
A-4	5cm/5cm/150cm	1	150cm	0,0038
A-5	5cm/5cm/30cm	1	30cm	0,0008
A-6	5cm/5cm/30cm	1	30cm	0,0008
A-7	5cm/5cm/30cm	1	30cm	0,0008
A-8	5cm/5cm/30cm	1	30cm	0,0008
A-9	5cm/5cm/140cm	1	140cm	0,0035
A-10	5cm/5cm/140cm	1	140cm	0,0035
	Razem	10	1070cm	0,0267

Konstrukcja ambony myśliwskiej

Konstrukcja ściany - A

www.lech-bud.org

Grzegorz Woźny

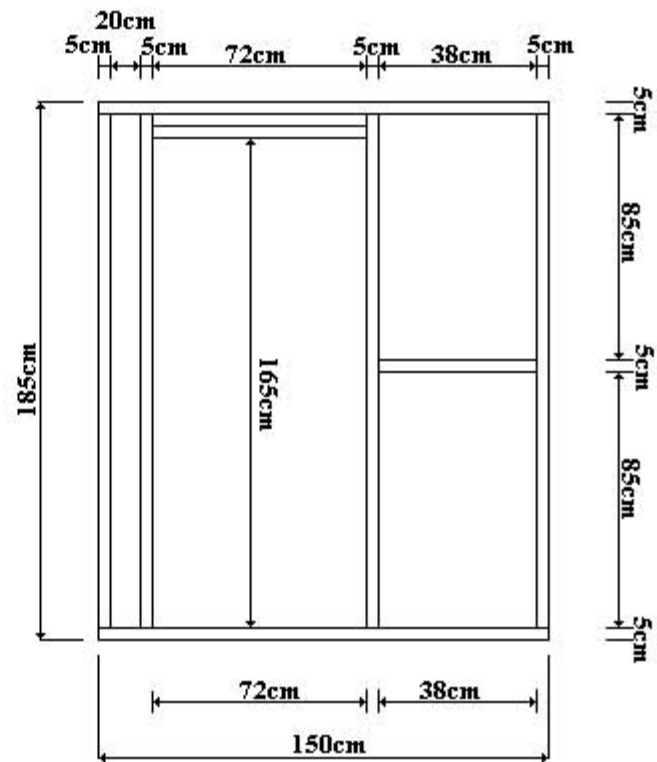
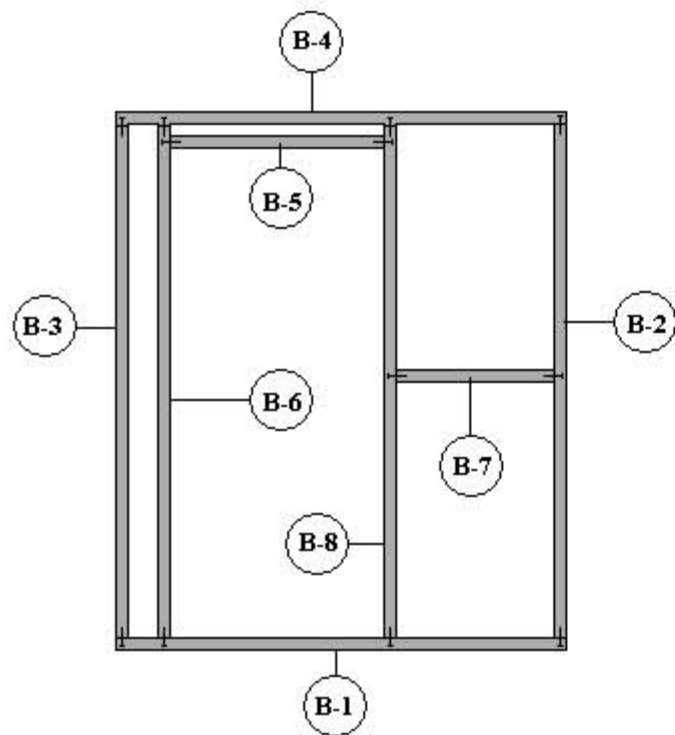

Nr. Elementu	Wymiar	Sztuki	mb	m3
B-1	5cm/5cm/150cm	1	150cm	0,0038
B-2	5cm/5cm/175cm	1	175cm	0,0044
B-3	5cm/5cm/175cm	1	175cm	0,0044
B-4	5cm/5cm/150cm	1	150cm	0,0038
B-5	5cm/5cm/72cm	1	72cm	0,0018
B-6	5cm/5cm/175cm	1	175cm	0,0044
B-7	5cm/5cm/38cm	1	38cm	0,0010
B-8	5cm/5cm/175cm	1	175cm	0,0044
Razem		8	1110cm	0,0278

Konstrukcja ambony myśliwskiej

Konstrukcja ściany - B

www.lech-bud.org

Grzegorz Woźny

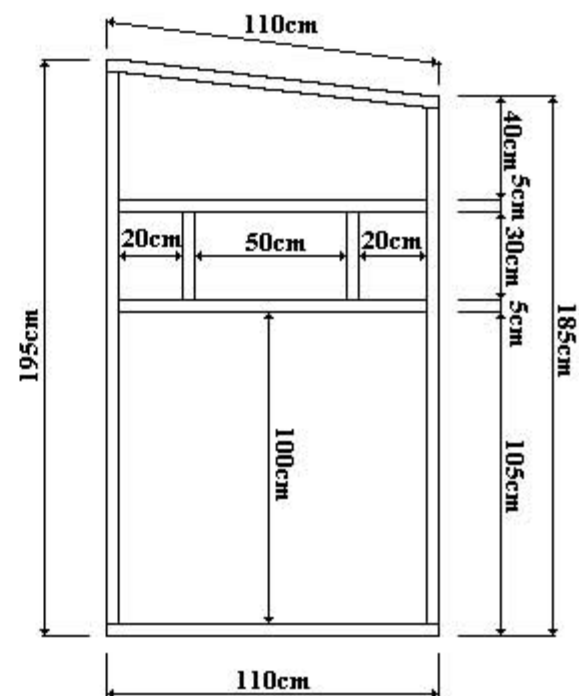
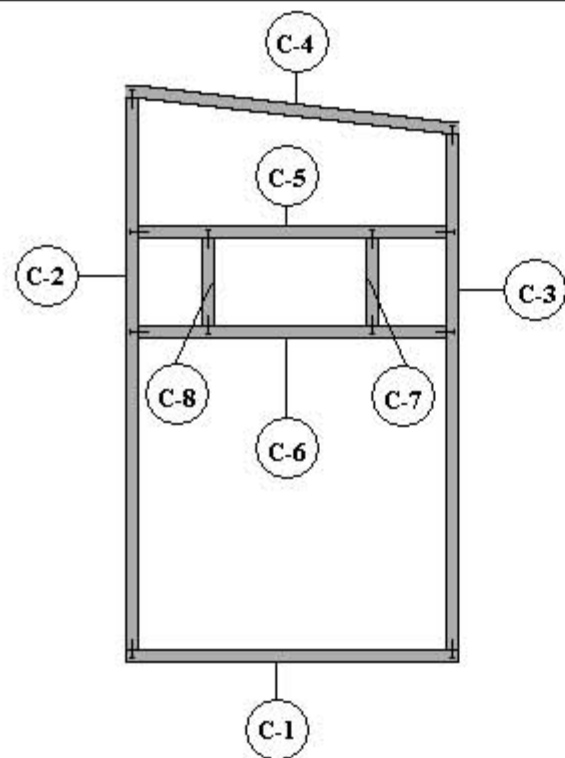

Nr. Elementu	Wymiar	Sztuki	mb	m3
C-1	5cm/5cm/110cm	1	110cm	0,0028
C-2	5cm/5cm/195cm	1	195cm	0,0049
C-3	5cm/5cm/185cm	1	185cm	0,0046
C-4	5cm/5cm/110cm	1	110cm	0,0028
C-5	5cm/5cm/100cm	1	100cm	0,0025
C-6	5cm/5cm/100cm	1	100cm	0,0025
C-7	5cm/5cm/30cm	1	30cm	0,0008
C-8	5cm/5cm/30cm	1	30cm	0,0008
	Razem	8	860cm	0,0215

Konstrukcja ambony myśliwskiej

Konstrukcja ściany - C

www.lech-bud.org

Grzegorz Woźny

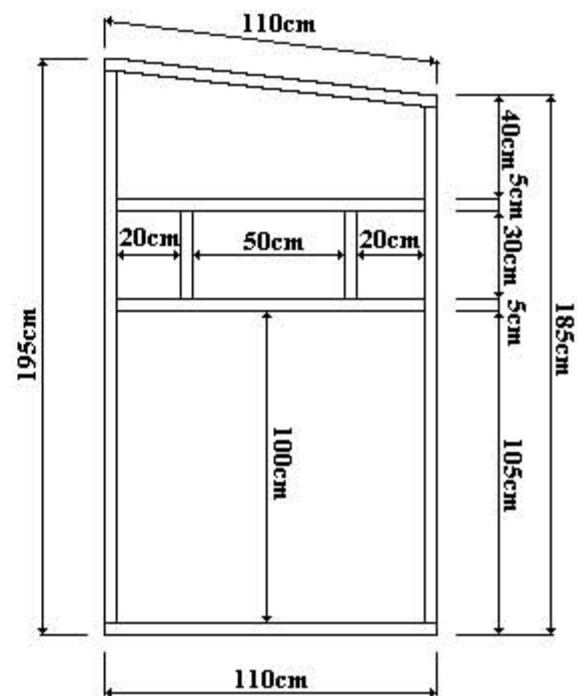
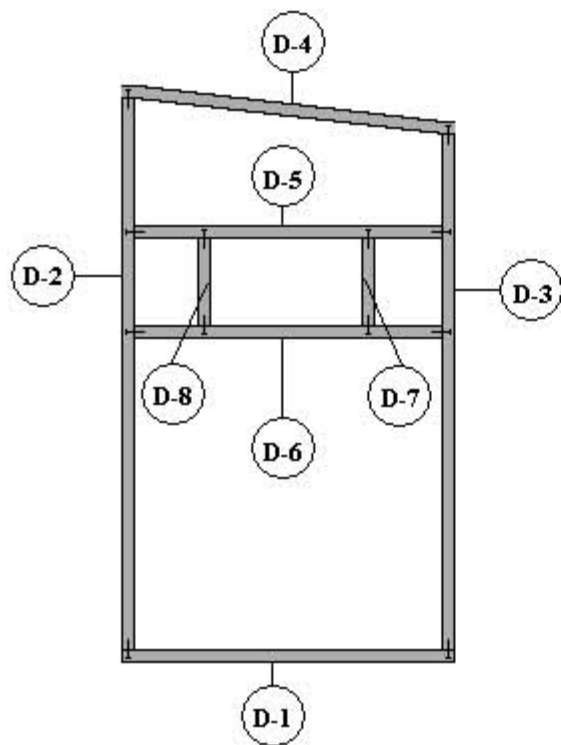

Nr. Elementu	Wymiar	Sztuki	mb	m3
D-1	5cm/5cm/110cm	1	110cm	0,0028
D-2	5cm/5cm/195cm	1	195cm	0,0049
D-3	5cm/5cm/185cm	1	185cm	0,0046
D-4	5cm/5cm/110cm	1	110cm	0,0028
D-5	5cm/5cm/100cm	1	100cm	0,0025
D-6	5cm/5cm/100cm	1	100cm	0,0025
D-7	5cm/5cm/30cm	1	30cm	0,0008
D-8	5cm/5cm/30cm	1	30cm	0,0008
Razem		8	860cm	0,0215

Konstrukcja ambony myśliwskiej

Konstrukcja ściany - D

www.lech-bud.org

Grzegorz Woźny

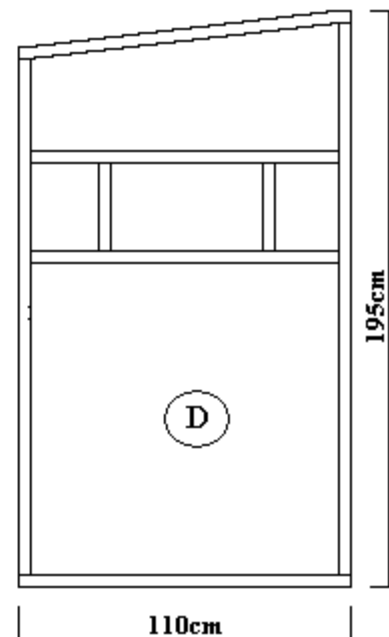
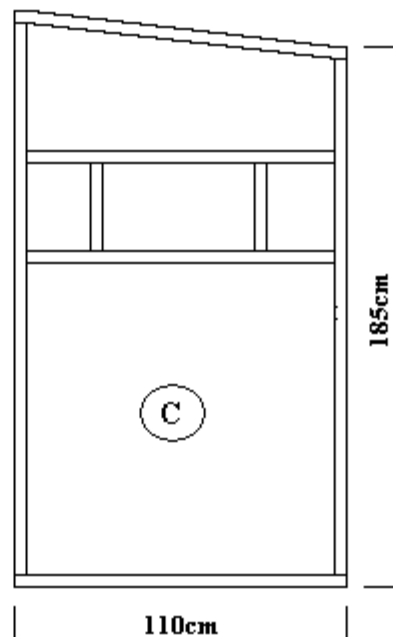
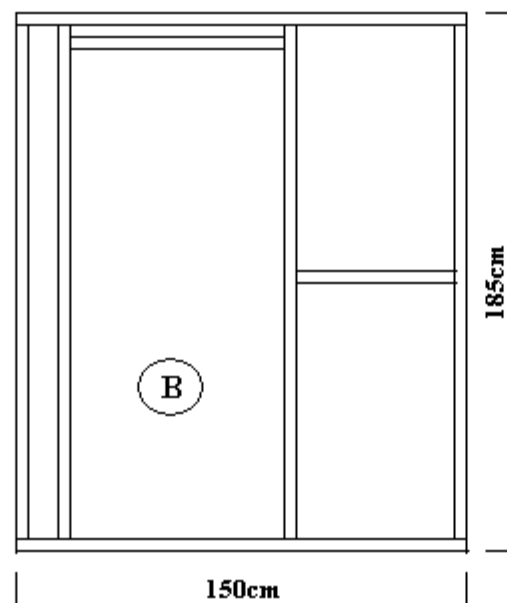
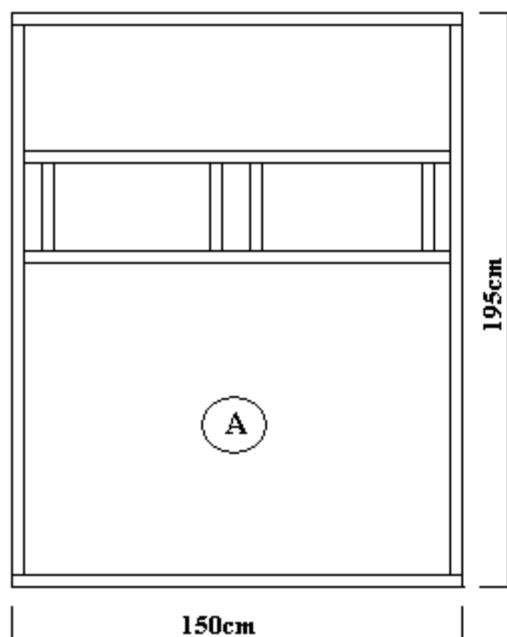

Konstrukcja ambony myśliwskiej

Konstrukcja ściany zewnętrznej

www.lech-bud.org

Lech Grzegorz Woźny

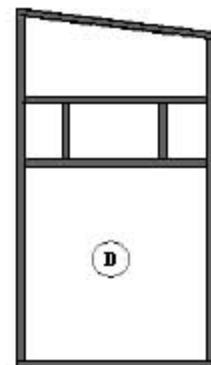
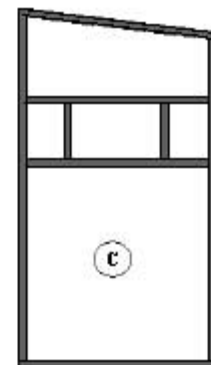
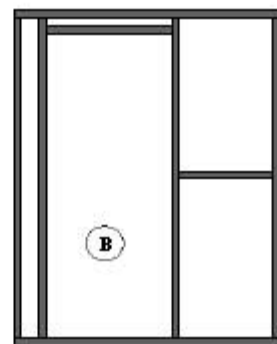
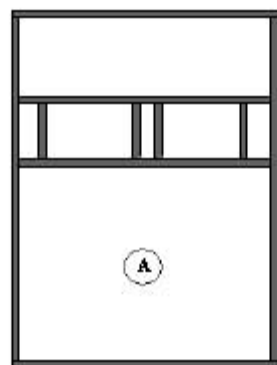
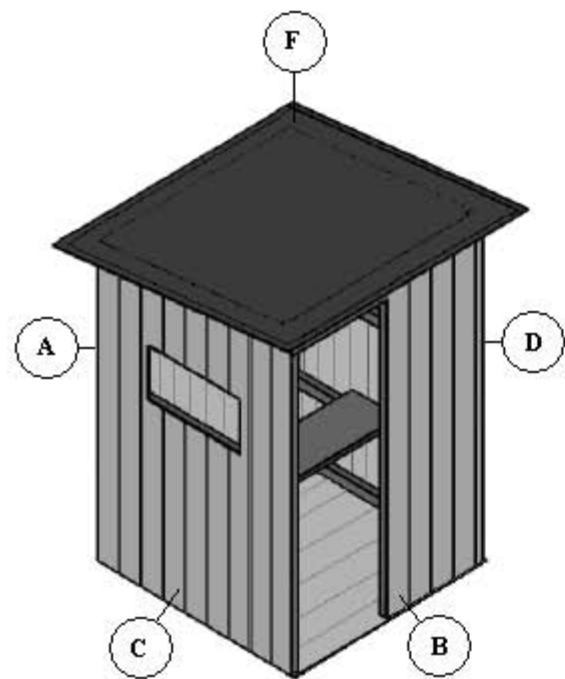

Konstrukcja ambony myśliwskiej

www.lech-bud.org

Grzegorz Woźny

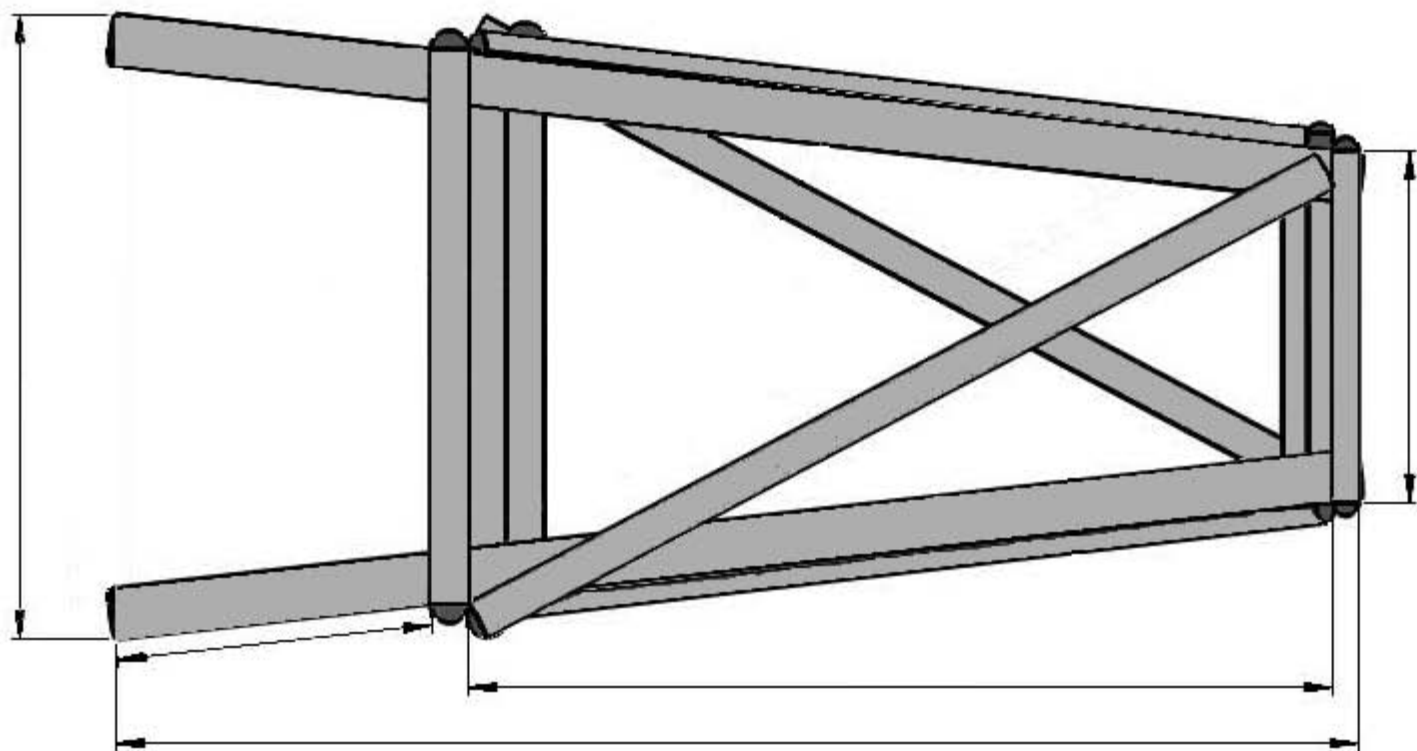

Konstrukcja ambony myśliwskiej

Konstrukcja podpory

www.lech-bud.org

Grzegorz Woźny

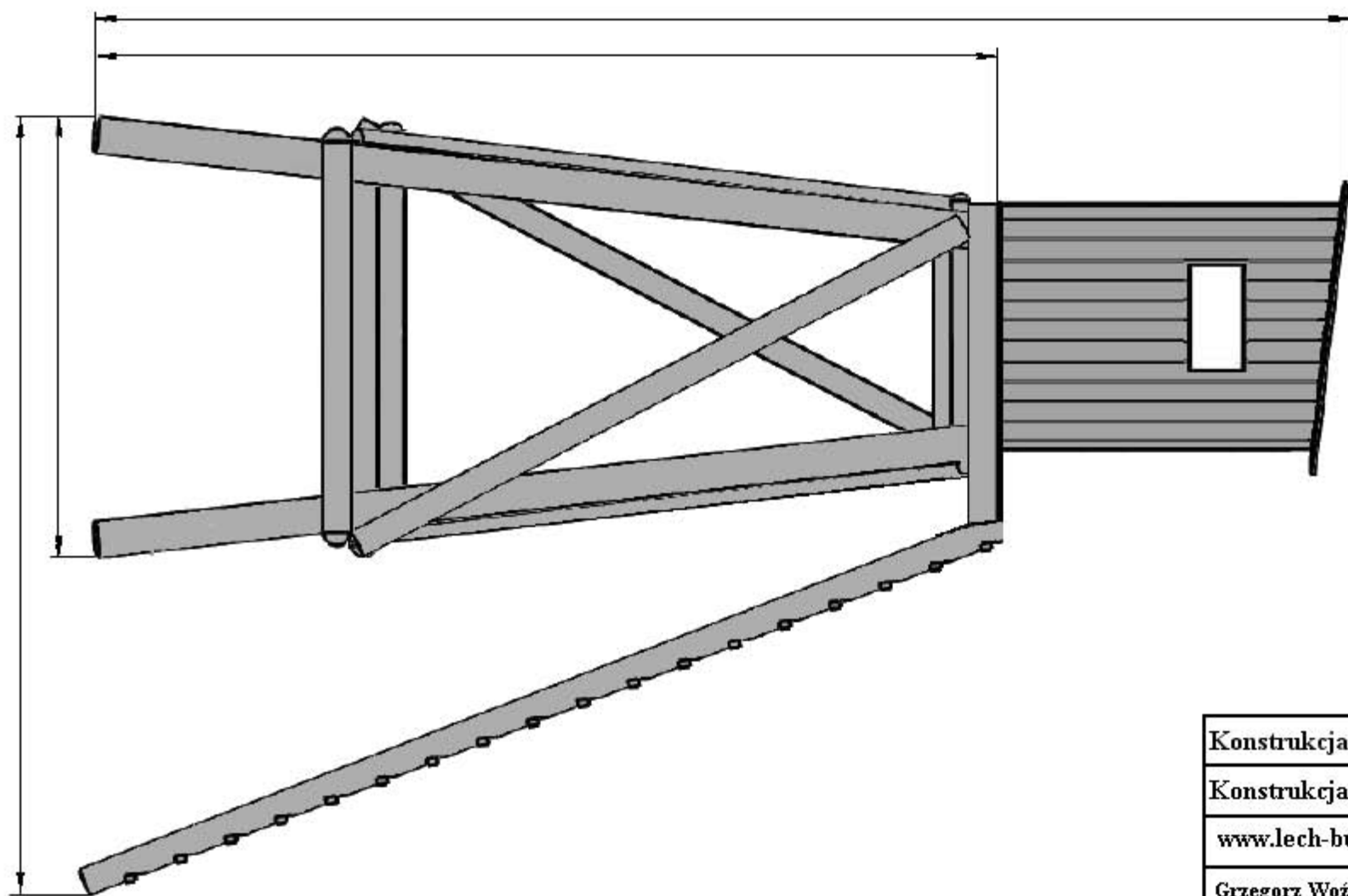

Konstrukcja ambony myśliwskiej

Konstrukcja

www.lech-bud.org

Grzegorz Woźny

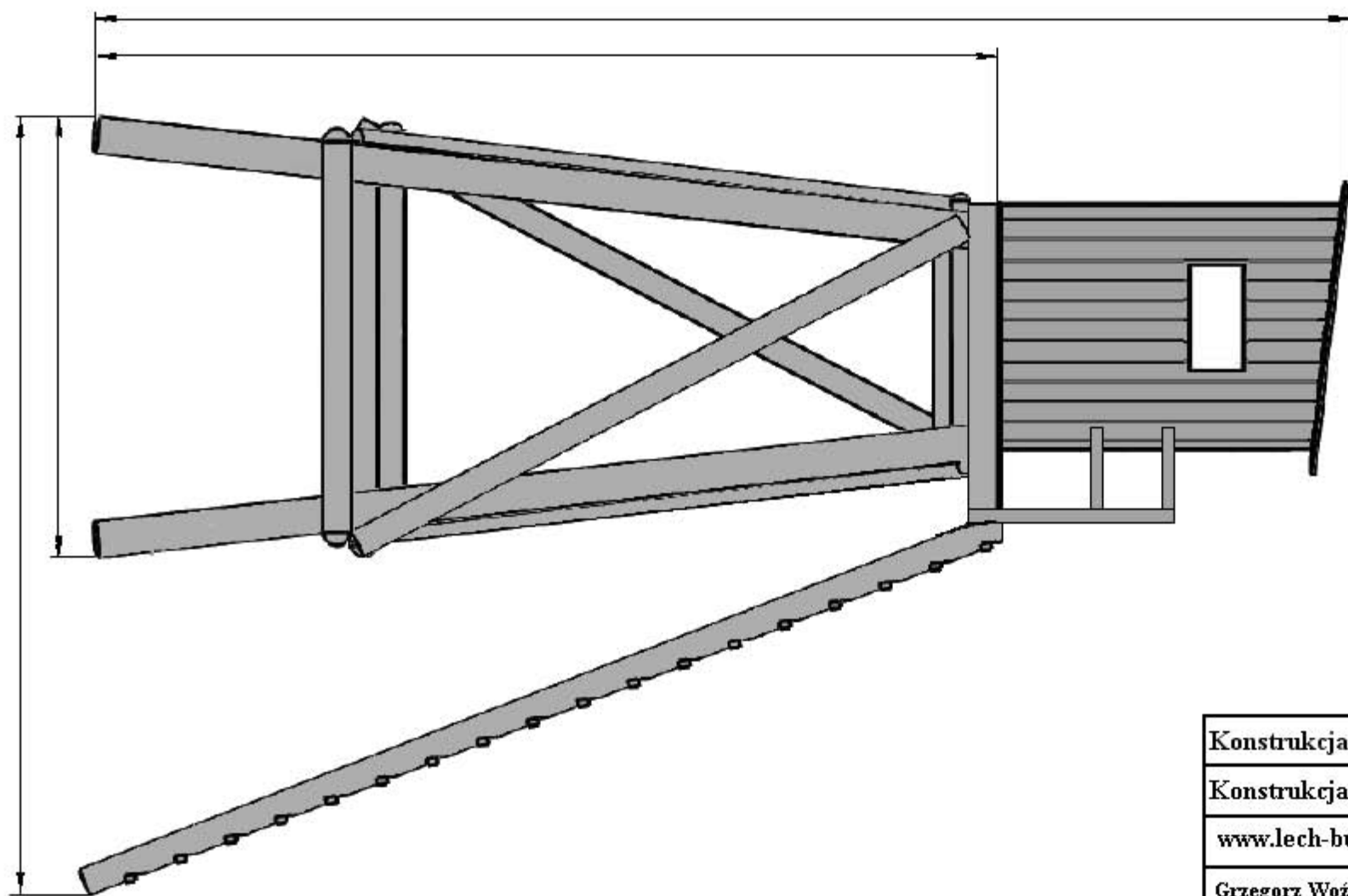

Konstrukcja ambony myśliwskiej

Konstrukcja

www.lech-bud.org

Grzegorz Woźny

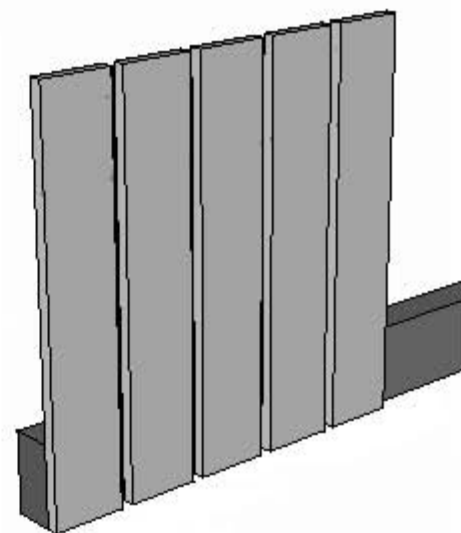
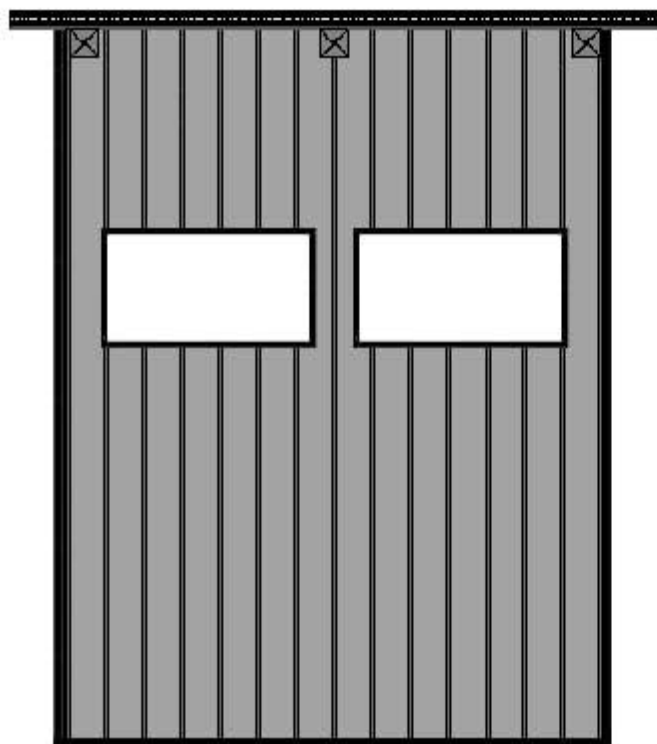

Konstrukcja ambony myśliwskiej

Ściana - A

www.lech-bud.org

Grzegorz Woźny

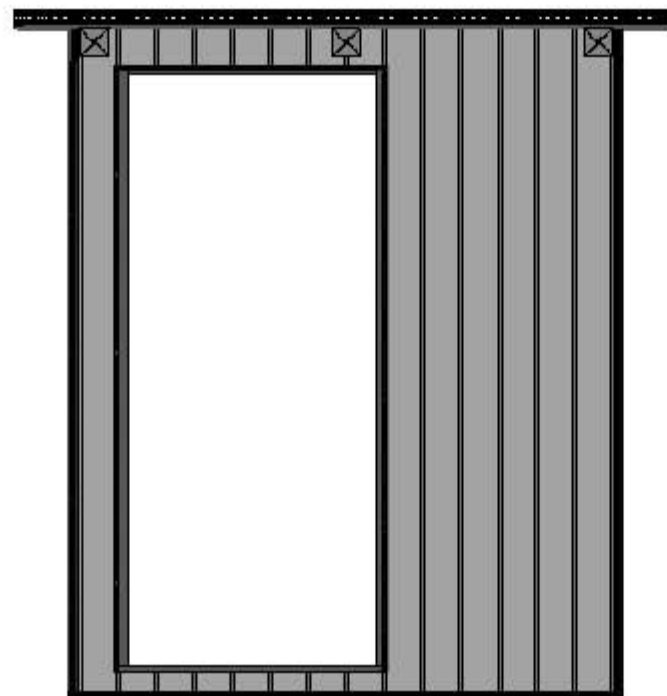

Konstrukcja ambony myśliwskiej

Ściana - B

www.lech-bud.org

Grzegorz Woźny

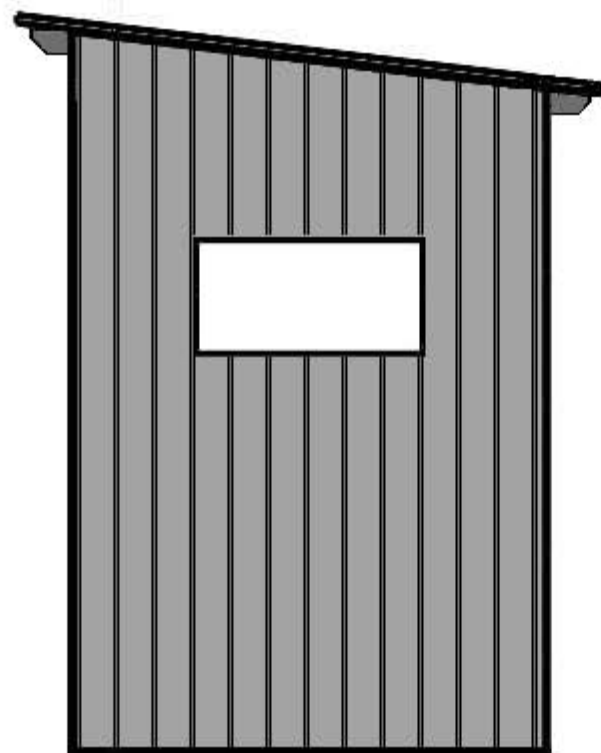

Konstrukcja ambony myśliwskiej

Ściana - C

www.lech-bud.org

Grzegorz Woźny

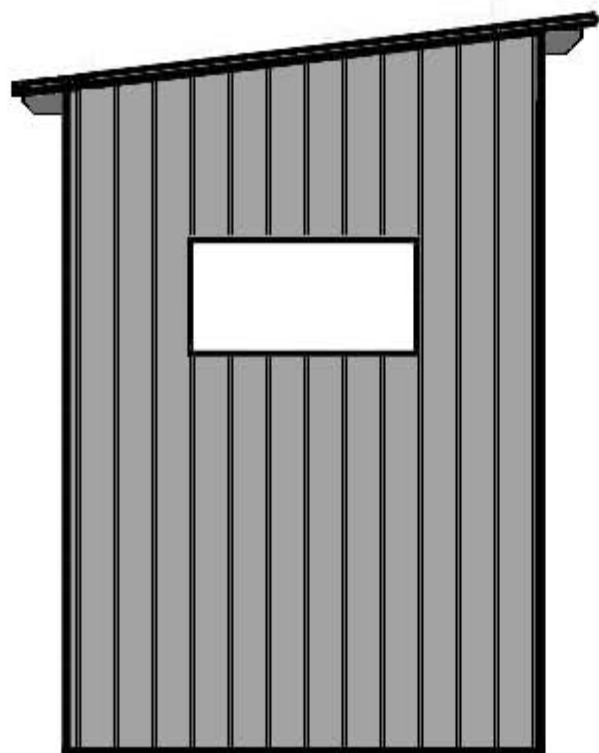

Konstrukcja ambony myśliwskiej

Ściana - D

www.lech-bud.org

Grzegorz Woźny